

LockMaster™

Sliding Gate Operator User's Manual

Model:

DSR 400

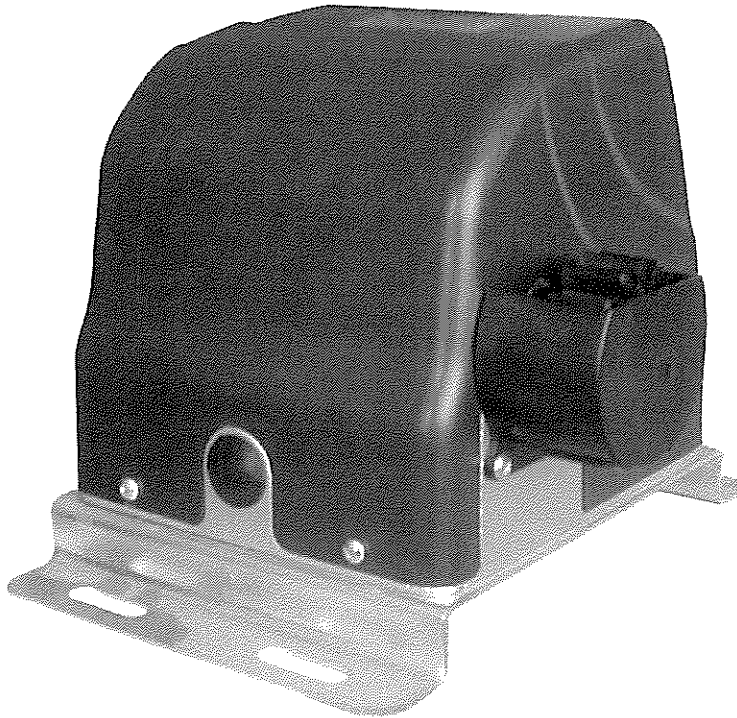

- ★ Please read and follow all warnings, precautions and instructions before installation and use
- ★ Periodic checks of the operator are required to ensure safe operation.
- ★ For residential use only
- ★ Save this manual



Table of Contents

General Safety	2
Important Safety Instructions	3
Preparation for Installation	5
Parts List	6
Optional Accessories Part List	7
Technical Specifications & Feature	7
Installation Overview	8
Installation of the Operator	8
Manual Operation	9
Fit the plastic rack reinforced with steel	10
Installation of the Limit Switch	11
Connecting Of Power Supply	12
Connecting of the Control Board	12
Setting of the Control Board	14
Test the reversing sensitivity	15
How to learn or erase the remote	16
How to use the remote to control the operator	16
Trouble Shooting	16
Maintenance	17

Thank you for purchasing DSR400 sliding gate operator. We are sure that the products will be greatly satisfying as soon as you start to use it.

The product is supplied with a user's manual which encloses installation and safety precautions. These should be read carefully before installation and operation as they provide important information about safety, installation, operation and maintenance. This product complies with the recognized technical standards and safety regulations.

General Safety



WARNING! An incorrect installation or improper use of the product can cause damage to persons, animals or properties.

- Scrap packing materials (plastic, cardboard, polystyrene etc.) according to the provisions set out by current standards. Keep nylon or polystyrene bags out of children's reach.
- This product was exclusively designed and manufactured for the use specified in the present documentation. Any other use not specified in this documentation could damage the product and be dangerous.
- The factory declines all responsibility for any consequences resulting from improper use of the product, or use which is different from that expected and specified in the present documentation.
- Do not install the product in explosive atmosphere.
- The factory declines all responsibility for any consequences resulting from failure to observe Good Technical Practice when constructing closing structures (door, gates etc.), as well as from any deformation which might occur during use.
- Disconnect the electrical power supply before carrying out any work on the installation. Also disconnect any buffer batteries, if fitted.
- Fit an omnipolar or magnetothermal switch on the mains power supply, having a contact opening distance equal to or greater than 3,5 mm.
- Check that a differential switch with a 0.03A threshold is fitted just before the power supply mains.
- Check that earthing is carried out correctly: connect all metal parts for closure (doors, gates etc.) and all system components provided with an earth terminal.
- Fit all the safety devices (photocells, electric edges etc.) which are needed to protect the area from any danger caused by squashing, conveying and shearing.
- Position at least one luminous signal indication device (blinker) where it can be easily seen, and fix a Warning sign to the structure.
- The factory declines all responsibility with respect to the automation safety and correct operation when other supplier's components are used.
- Only use original parts for any maintenance or repair operation.
- Do not modify the automation components, unless explicitly authorized by the factory.
- Instruct the product user about the control systems provided and the manual opening operation in case of emergency.
- Do not allow persons or children to remain in the automation operation area.
- Keep radio control or other control devices out of children's reach, in order to avoid unintentional automation activation.
- The user must avoid any attempt to carry out work or repair on the automation system, and always request the assistance of qualified personnel.
- Anything which is not expressly provided for in the present instructions is not allowed.
- Installation must be carried out using the safety devices and controls prescribed by the EN 12978 Standard.

Important Safety Instructions



WARNING – To reduce the risk of injury or death:

- 1) READ AND FOLLOW ALL INSTRUCTIONS.
- 2) Never let children operate or play with gate controls. Keep the remote control away from children.
- 3) Always keep people and objects away from the gate. NO PERSON SHOULD CROSS THE PATH OF THE MOVING GATE.
- 4) Test the gate operator monthly. The gate MUST reverse on contact with a rigid object or stop when an object activates the non-contact sensors. After adjusting the force or the limit of travel, retest the gate operator. Failure to adjust and retest the gate operator properly can increase the risk of injury or death.
- 5) Use the emergency release only when the gate is not moving.
- 6) KEEP GATES PROPERLY MAINTAINED. Read the owner's manual. Have a qualified service person make repairs to gate hardware.
- 7) The entrance is for vehicles only. Pedestrians must use separate entrance.
- 8) SAVE THESE INSTRUCTIONS.

Safety Instructions for Installation

A. Install the gate operator only when:

- 1) The operator is appropriate for the construction of the gate and the usage Class of the gate,
- 2) All openings of a horizontal slide gate are guarded or screened from the bottom of the gate to a minimum of 4 feet (1.22 m) above the ground to prevent a 2-1/4 inch (57.2 mm) diameter sphere from passing through the openings anywhere in the gate, and in that portion of the adjacent fence that the gate covers in the open position,
- 3) All exposed pinch points are eliminated or guarded.
- 4) Guarding is supplied for exposed rollers.

B. The operator is intended for installation only on gates used for vehicles. Pedestrians must be supplied with a separate access opening. The pedestrian access opening shall be designed to promote pedestrian usage. Locate the gate such that persons will not come in contact with the vehicular gate during the entire path of travel of the vehicular gate.

C. The gate must be installed in a location so that enough clearance is supplied between the gate and adjacent structures when opening and closing to reduce the risk of entrapment.

D. The gate must be properly installed and work freely in both directions prior to the installation of the gate operator. Do not over-tighten the operator clutch or pressure relief valve to compensate for a damaged gate.

E. For gate operators utilizing Type D protection:

- 1) The gate operator controls must be placed so that the user has full view of the gate area when the gate is moving.
- 2) The placard provided marked in letters at least 1/4-in (6.4-mm) high with the word "WARNING" and the following statement or the equivalent: "Moving Gate Has the Potential of Inflicting Injury or Death – Do Not Start Gate Unless Path is Clear" shall be placed adjacent to the controls,
- 3) An automatic closing device (such as a timer, loop sensor, or similar device) shall not be employed.
- 4) No other activation device shall be connected.

F. Controls intended for user activation must be located at least ten feet (10') away from any moving part of the gate and where the user is prevented from reaching over, under, around or through the gate to operate the controls. Outdoor or easily accessible controls shall have a security feature to prevent unauthorized use.

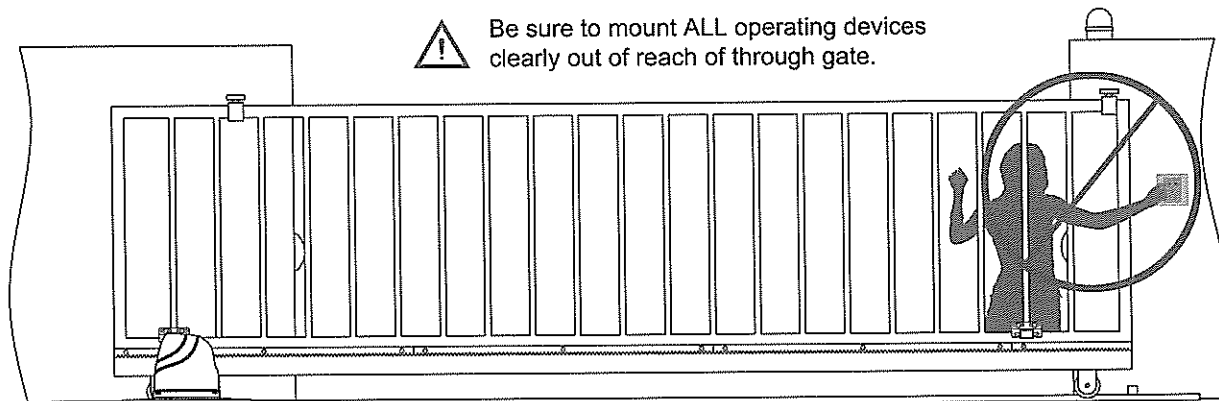

G. The Stop and/or Reset button must be located in the line-of-sight of the gate. Activation of the reset control shall not cause the operator to start.

H. A minimum of two (2) WARNING SIGNS shall be installed, one on each side of the gate where easily visible.

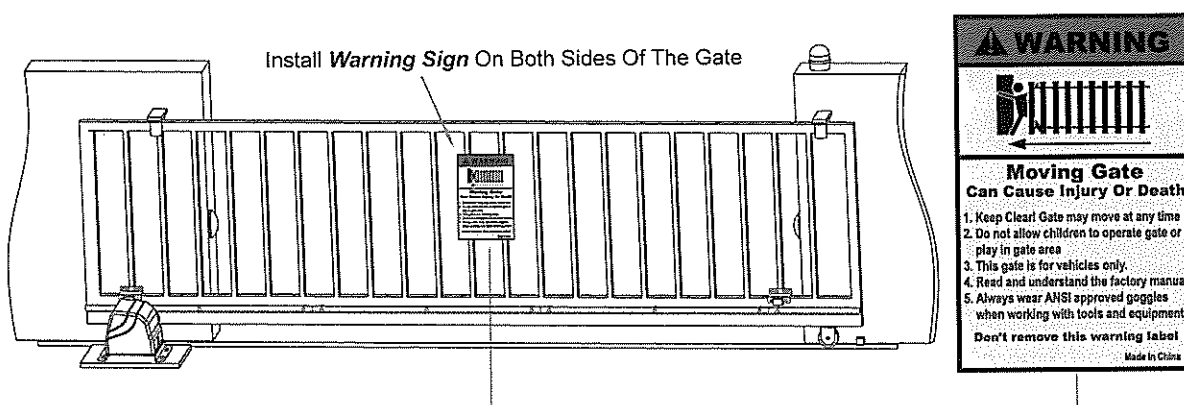

I. For a gate operator utilizing a non-contact sensor in accordance Usage Class:

- 1) See instructions on the placement of non-contact sensors for each Type of application,
- 2) Care shall be exercised to reduce the risk of nuisance tripping, such as when a vehicle trips the sensor while the gate is still moving in the opening direction.
- 3) One or more non-contact sensors shall be located where the risk of entrapment or obstruction exists, such as the perimeter reachable by a moving gate or barrier.

J. For a gate operator utilizing a contact sensor in accordance with Usage Class:

- 1) One or more contact sensors shall be located where the risk of entrapment or obstruction exists, such as at the leading edge, trailing edge, and post-mounted both inside and outside of a vehicular horizontal slide gate.
- 2) One or more contact sensors shall be located at the bottom edge of a vehicular vertical lift gate.
- 3) One or more contact sensors shall be located at the pinch point of a vehicular vertical pivot gate.
- 4) A hardwired contact sensor shall be located and its wiring arranged so that the communication between the sensor and the gate operator is not subjected to mechanical damage.
- 5) A wireless contact sensor such as one that transmits radio frequency (RF) signals to the gate operator for entrapment protection functions shall be located where the transmission of the signals are not obstructed or impeded by building structures, natural landscaping or similar obstruction. A wireless contact sensor shall function under the intended end-use conditions.
- 6) One or more contact sensors shall be located on the inside and outside leading edge of a sliding gate. Additionally, if the bottom edge of a sliding gate is greater than 6 inches (152 mm) above the ground at any point in its arc of travel, one or more contact sensors shall be located on the bottom edge.
- 7) One or more contact sensors shall be located at the bottom edge of a vertical barrier (arm).

Preparation for Installation

Before proceeding to your operator installation, check if your gate structure is in accordance with the current standards, especially as follows:

The gate sliding track is linear and horizontal, and the wheels are suitable, the gate should be mounted and moving freely. Check that the structure is sufficiently strong and rigid, and that its dimensions and weights conform to those listed in the specifications table of this document. Make sure that the gate is plumb and level. The fence posts must be mounted in concrete. The gate does not bind or drag on the ground.

- The gate manual operation can be carried out smoothly along its entire run, and there is no excessive side slipping.
- The opening and closing gate stops are positioned.



WARNING: Remember that control devices are intended to facilitate gate operation, but can not solve problems due to any defects or deficiency resulting from failure to carry out correct installation or maintenance. Take the product out of its packing and inspect it for damage. Should it be damaged, contact your dealer. Remember to dispose of its components (cardboard, polystyrene, nylon, etc.) according to the current prescriptions.

Refer to the following Figures for gate installation.

Using the post or wall as a stop, either directly or indirectly, is not recommended so as to protect the post or wall against damaging shock from the sliding gate.

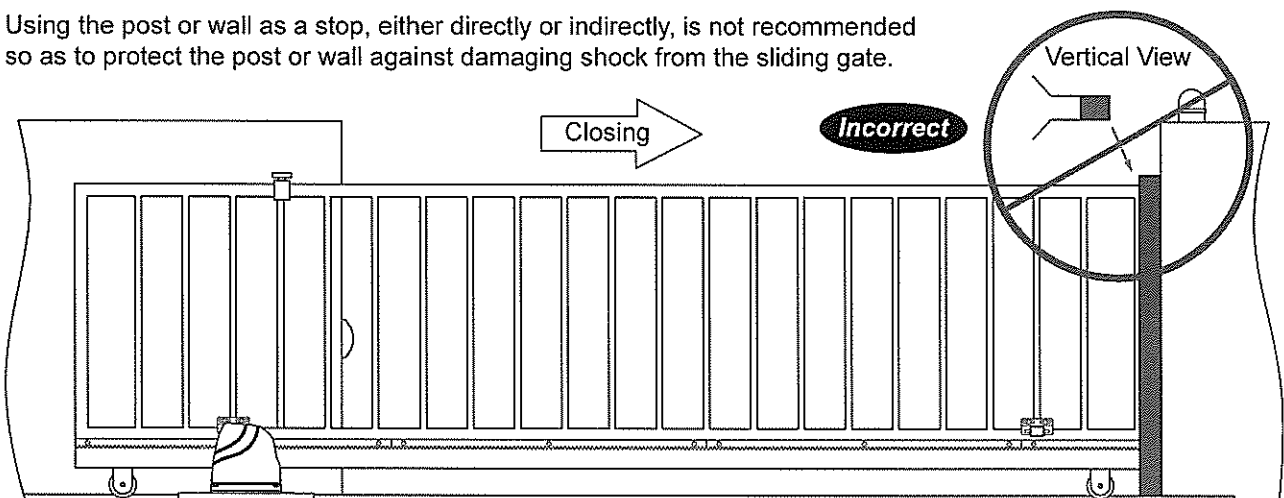



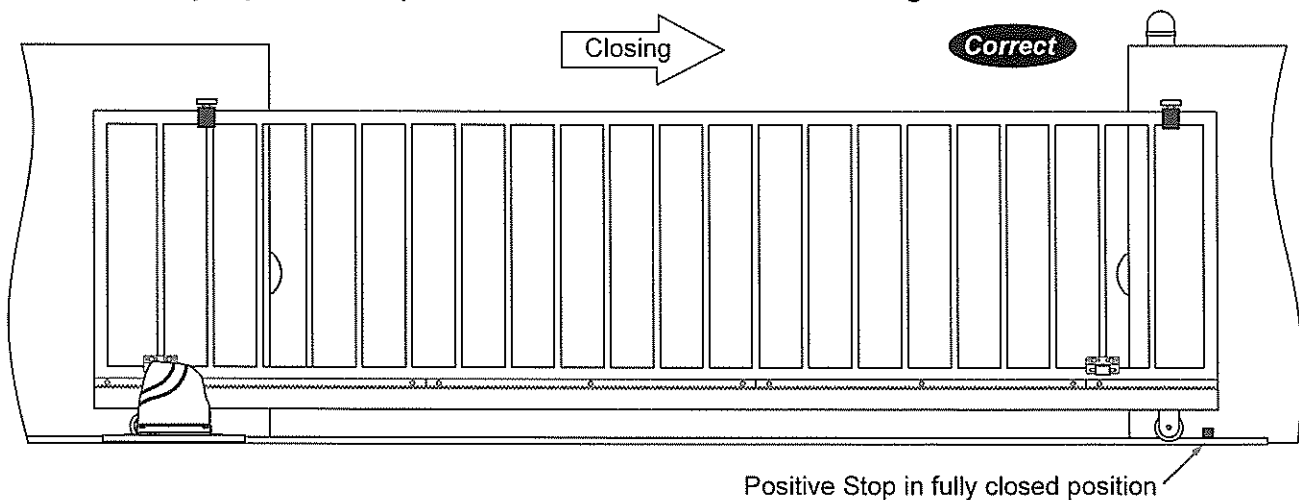

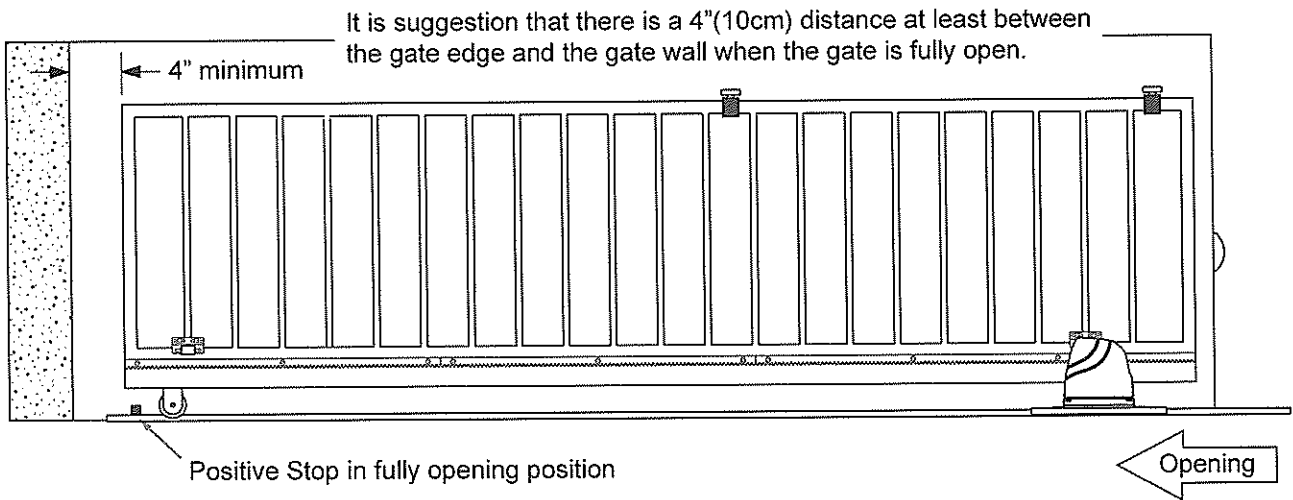

In sake of safety, a positive stop must be mounted on the two end of ground track.



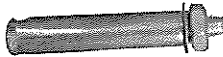
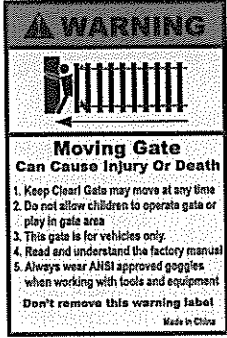
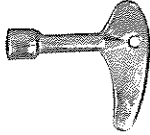
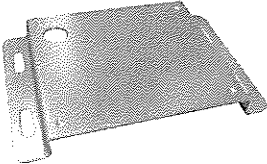
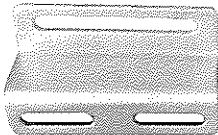

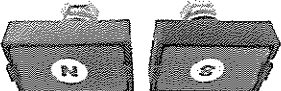
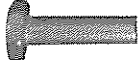
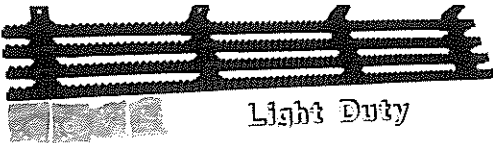

Parts List

 <p>Gate Operator (1 pc)</p>	 <p>Remote Control (2 pcs)</p>	 <p>Expansion Bolt (4 pcs)</p>			 <p>Warning Signs (2 pcs)</p>
	 <p>Release Key (1 pc)</p>	 <p>Base Plate (1 pc)</p>			
 <p>Magnet Bracket (2 pcs)</p>	 <p>M8x70 Bolt (4 pcs)</p>	 <p>Φ8 Washer (8 pcs)</p>	 <p>Φ8 Lock Washer (8 pcs)</p>	 <p>M8 Nut (4 pcs)</p>	
 <p>Magnet Assembly (N pole & S pole)</p>	 <p>M8x20 Bolt (4 pcs)</p>	 <p>4pcs Light Duty Plastic Rack Reinforced with Steel 1005mm×N(pcs) (Optional)</p>			

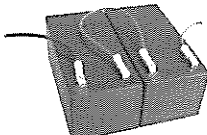
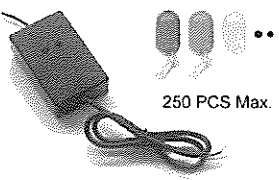
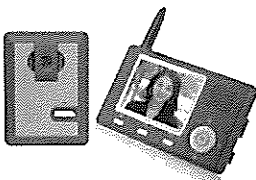
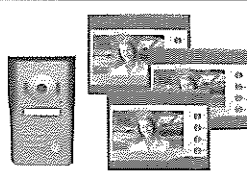
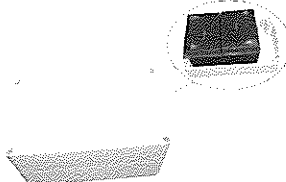
Optional Accessories Parts List

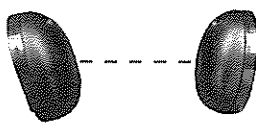
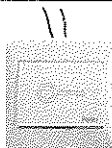
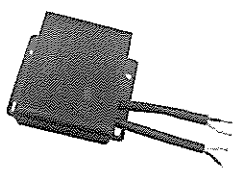
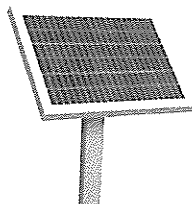
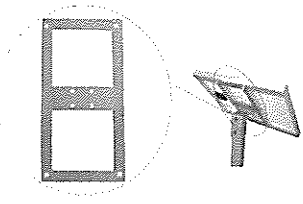
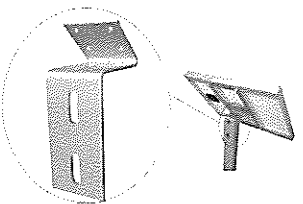
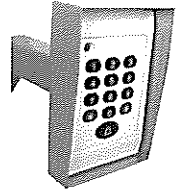
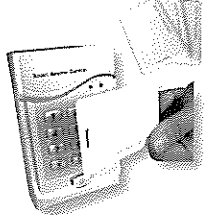
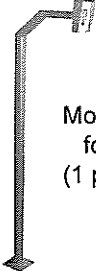
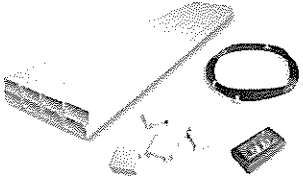
Optional			
 Back up battery (1 set) (LM125)	 250 PCS Max. External Receiver (1 pc) (LM138)	 2.5" Video Intercom (1 set) (LM162)	 7" Video Intercom (1 set) (LM165)
 Back up battery box(1 pc) (LM130)	 Alarm Lamp (1 pc) (LM140)	 Photocell Beam System (1 set) (LM102)	 Wall push button (1 pc) (LM147)
 Solar Controller (1 pc) (LM117)	 Solar panel (1 pc) (LM109)	 Supporting frame for solar panel (1 pc) (LM115)	 Bracket for solar panel (1 pc) (LM116)
 Keypad (wireless) (1 pc) (LM105)	 Wired Keypad (1 pc)(LM106/24) ID card (LM170)	 Mounting post for keypad (1 pc) (LM107)	 Loop Detector (1 pc) (LM155)

Technical Specifications & Features

Specifications

- Power supply: 120V/60HZ or 230V/50HZ
- Motor: 24VDC
- Absorbed power: 120W
- Gate moving speed: (7 "/second) 18 cm/second
- Max gate weight: 400KGS
- Max torque: 8Nm
- Environmental conditions: from -15°C to +40°C
- Protection class: IP44

·Dimensions: 29.5×20×22.5 CM

Features:

- Soft start and soft stop
- Midway mode
- Easy to install and low maintain
- Quick selection for the gate open/close direction
- Reliable rolling code technology
- Emergency release key in case of power failure
- Stop/Reverse in case of obstruction during gate opening/closing
- Built in adjustable auto-close (0, 30, 60, 90 seconds)
- Built in max. 90 seconds Motor running time (MRT) for multiple safety protection
- Reliable electromagnetism limit for easy adjustment
- Optional accessories

Installation Overview

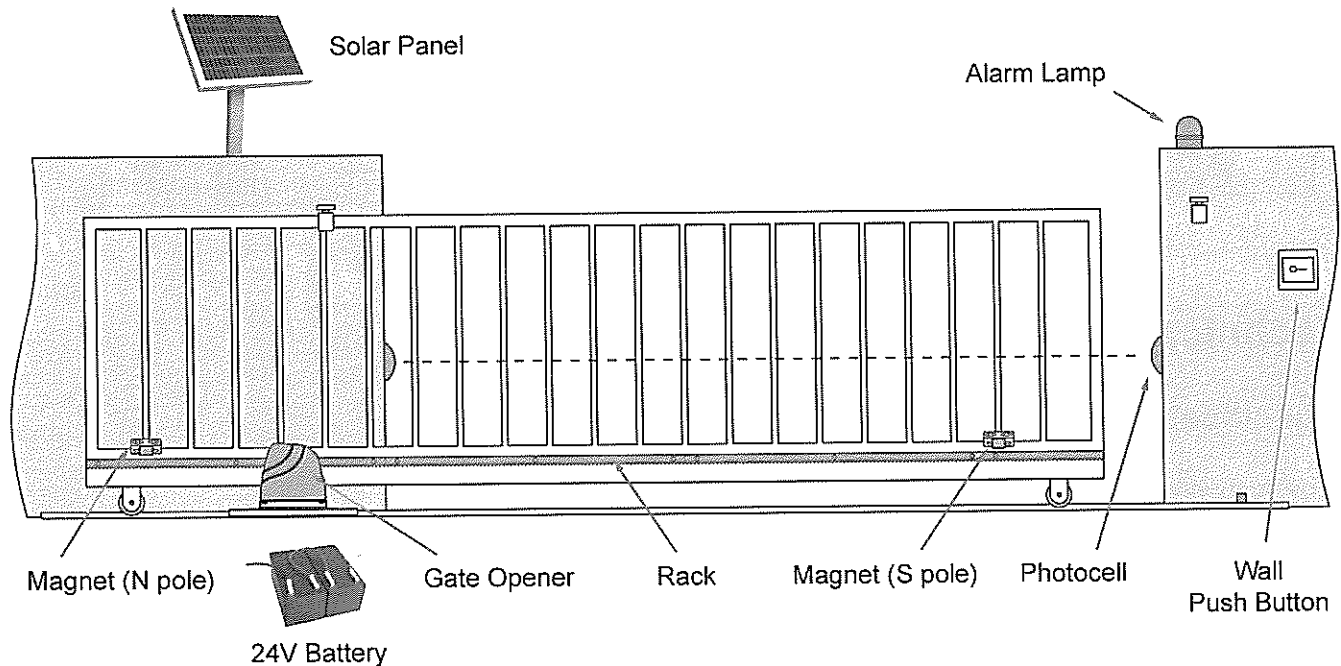

Installation of the Operator

Caution:

*Be sure that the operator is installed in a level and paralleled position and is properly secured. Improper installation could result in property damage, severe injury, and/or death.

* Before starting installation, ensure that there is no point of friction during the entire movement of the gate and there is no danger of derailment.

* Ensure that the *Warning Signs* are present.

Necessary Tools: The following tools may be necessary to install the Gate operator. You will need screwdrivers, an electric drill, wire cutters and a wire stripper, a socket set, and possibly access to a welder.

When install the operator, you should build a concrete pad to support the base plate of operator in order to maintain proper stability.

The installation proceeds are as follows:

1. Dig a hole for a concrete pad which should be approximately 50 x 32 x 35cm (20" x 13" x 14"). It may protrude 10 cm (4") above ground and 25 cm (10") in depth underground. Increase the pad height if necessary to protect the system from flooding, heavy snow etc.

2. Prepare one or more conduits for the electrical cables before pour concrete. Remember that cable conduits have to pass through the hole in the base plate.

3. Pour concrete and before it starts to harden, check that it is parallel to the gate leaf and perfectly level.

4. Mark the position of four expansion anchors according to the position of mounting hole on the base plate as soon as concrete become harden. Double check your marking, move the base plate and drill the 4 holes using a 10mm (3/8") masonry bit. Put the 4 expansion anchors (provided) into the holes and firmly tighten.

5. Place the opener onto base plate. Check that it is perfectly parallel to the gate leaf, and then screw the four bolts and washers supplied. It's only temporary installation. Further adjustment will be required when install the rack.

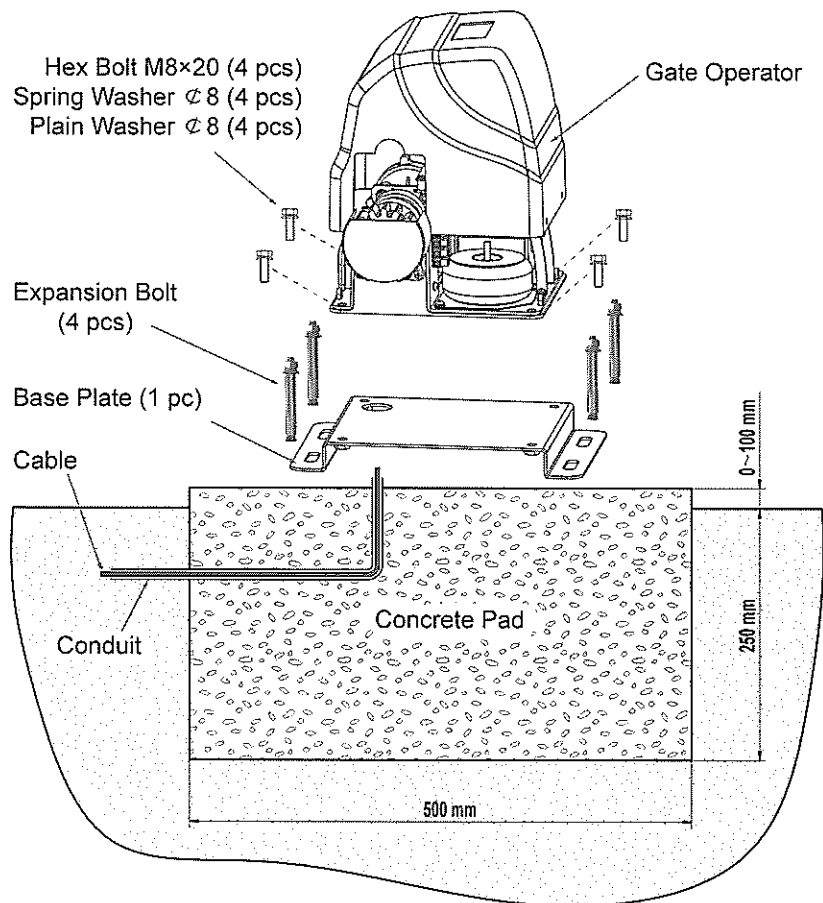

Manual Operation

The operator should be put in the manual (emergency release) position before fitting the rack, installing the operator and limit switch. The process is as follows:

1) Take of the rubber stopple.

2) Insert the Release Key (provided) and turn it in counter-clockwise 90° to disengage the clutch between the gear shaft and power output. Now the operator is in the manual operation.

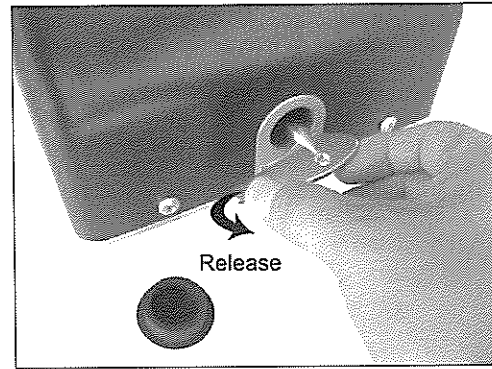
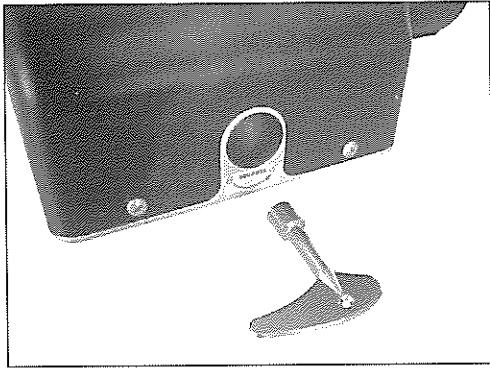

Fit the plastic rack reinforced with steel

1. Start with gate in closed position
2. There are four sections of plastic rack which is one meter length, each section for standard package. (you can order extra rack from dealer if necessary)
2. Put one end of rack section on the gear of operator as a temporary support. Make rack level and mark the rack's mounting holes on the gate.
3. Fit the rack by self-threading screws. This kind of plastic rack is quieter and allows height adjustments to be made even after it has been fixed. Please keep 1.0mm space between the rack and the gear to avoid the weight of the gate leaf effect on the operator.

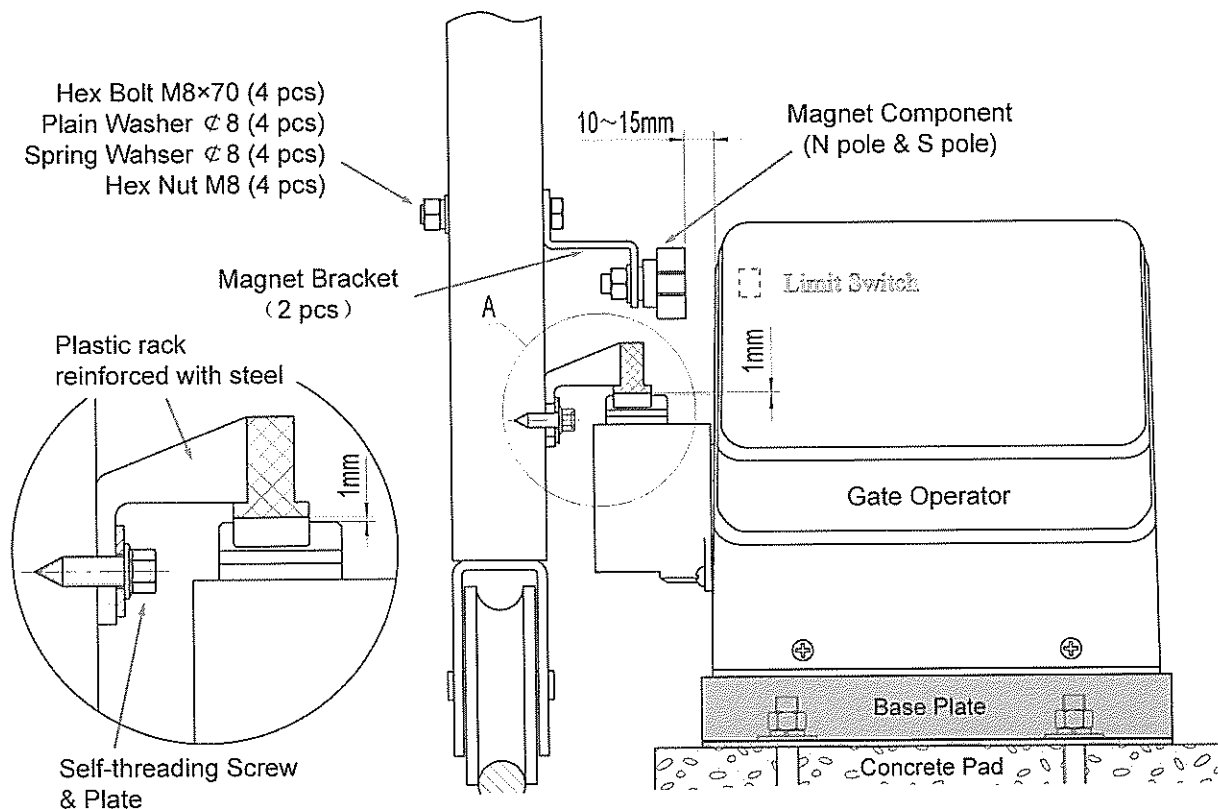

Important:

- * Check that the rack teeth must engage the gear teeth throughout their full thickness. If not, adjust the position of the operator or/and place a few shims between the rack and gate.
4. Manually slide the gate leaf to ensure the rack is proper on the gear of operator.
 5. Repeat same steps of first rack section to install the rest rack sections until proper length is reached.

6. Cut away any excess of the rack (Note: rack length must be longer than actual travel of the gate)
7. Thoroughly fasten the four nuts as well as spring washers onto expansion bolts tightly, enabling the operator is firmly secured on the concrete pad during the whole gate travel.

Installation of the Limit Switch

Before install limit switch, make sure the gate operator is put in manual operation. (the clutch connected with gear shaft is disengaged) and the mains power supply is disconnected.

Position the two Magnet Components approximately on the gate and move the gate by hand to fix them in place.

Fit magnets bracket

Push the gate fully closed by hand. Locate and install the magnet bracket so that the operator will stop at the desired close position when the close limit switch approaches it.

Push the gate fully open by hand. Locate and install the magnet bracket so that the operator will stop at the desired open position when the open limit switch approaches it.

The magnet component with N pole outside must be installed at left side and the magnet component with S pole outside must be installed at right side from the view inside of property.

Finally adjust the magnet to the proper position by moving the gate with the motor. The magnet should be less than 1" away from the magnetic limit switch. If it is too far away, the switch will fail to work. The distance between the magnet and the operator should be 0.39" - 0.59" with the operator cover on. Adjust the position of the magnet until the positions of the opening and closing meet the requirement.

Connecting Of Power Supply

The power supply cord should not be smaller than H05R1V-F, $3 \times 0.75\text{mm}^2$ (18AWG) for its diameter. Connect the live wire, neutral wire and earth wire to the "L", "N" and "PE" terminal respectively.

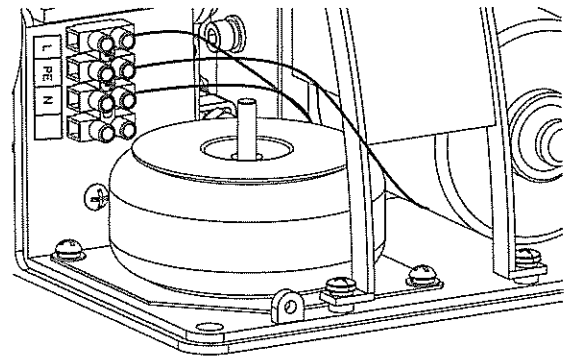

Connecting Of the Control Board

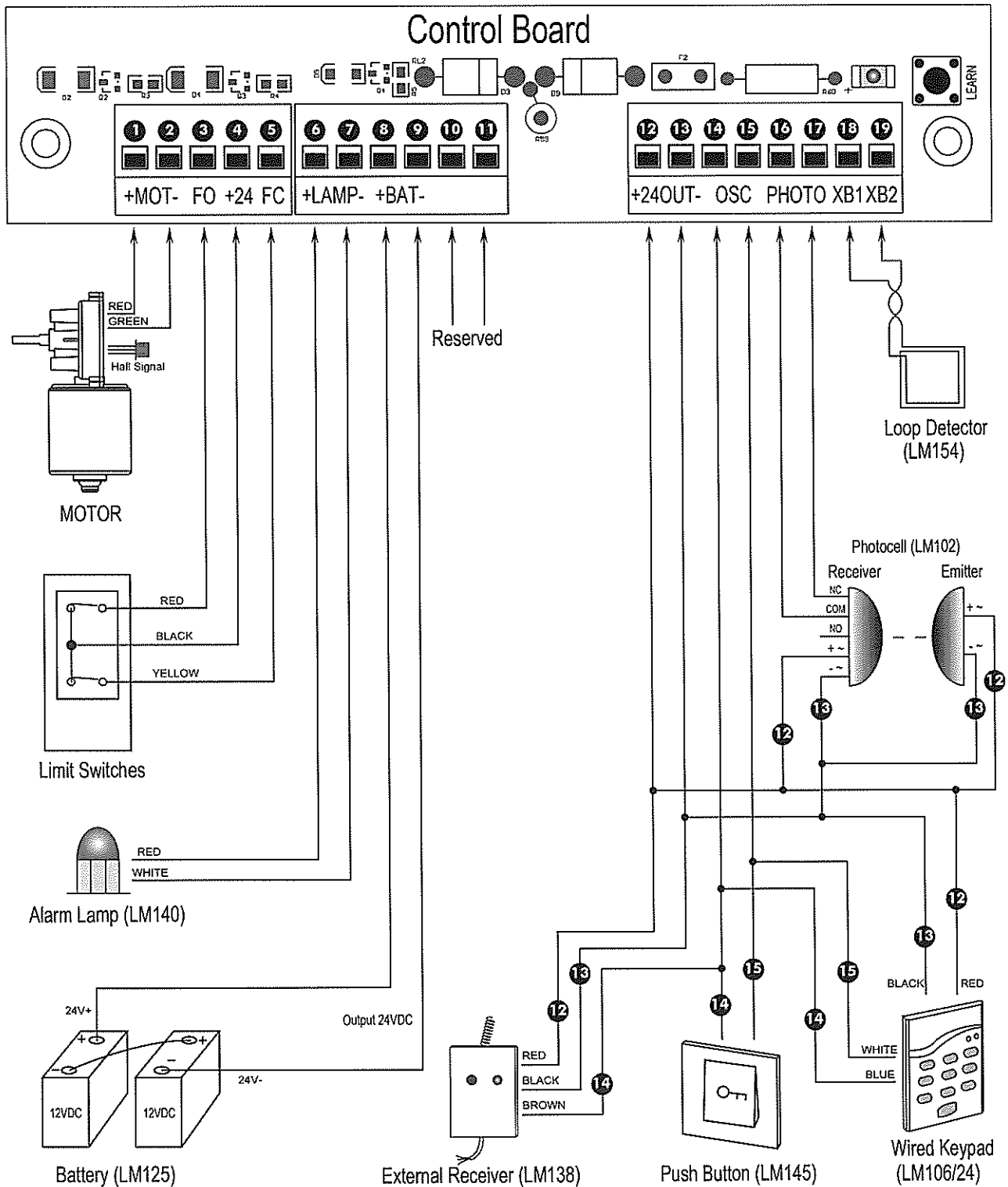

1. Motor

The **RED** wire of the motor should be connected into the "1" terminal.

The **GREEN** wire of the motor should be connected into the "2" terminal.

2. Limit Switches

The **RED** wire of the limit switches should be connected into the "3" terminal.

The **BLACK** wire of the limit switches should be connected into the "4" terminal.

The **YELLOW** wire of the limit switches should be connected into the "5" terminal.

3. Alarm Lamp (24VDC)

The **RED** wire of the alarm lamp should be connected into the "6" terminal.

The **WHITE** wire of the alarm lamp should be connected into the "7" terminal.

4. Battery

The **positive** terminal of the battery should be wired to the "8" terminal.

The **negative** terminal of the battery should be wired to the "9" terminal.

5. External Receiver

The **RED** wire of the external receiver should be connected into the "12" terminal.

The **BLACK** wire of the external receiver should be connected into the "13" terminal.

The **BROWN** wire of the external receiver should be connected into the "14" terminal.

6. Push Button

The push button should be wired to the "14" and "15" terminals. The gate operator works alternately by pushing the button (open-stop-close-stop-open).

7. Wired Keypad (24VDC)

The **RED** wire of the wired keypad should be connected into the "12" terminal.

The **BLACK** wire of the wired keypad should be connected into the "13" terminal.

The **BLUE** wire of the wired keypad should be connected into the "14" terminal.

The **WHITE** wire of the wired keypad should be connected into the "15" terminal.

8. Photocell

Use a 2-core cable to connect the "+ ~" terminal of the photocell's emitter to the "12" terminal, the "- ~" terminal to the "13" terminal. Also the "+ ~" and "- ~" terminals of the photocell's receiver should be connected to the "12" and "13" terminals in parallel.

Use another 2-core cable to connect the "COM" terminal of the receiver to the "16" terminal, the "NC" terminal to the "17" terminal.



TIPS

The terminal 16 and 17 on control board should be shorted if the photocell beam system (optional) does not use. A wire jumper has been used for short to terminal 16 and 17 in factory.

Please check if this wire jumper is missing or keep the photocell in alignment when the gate can open but fails to close.

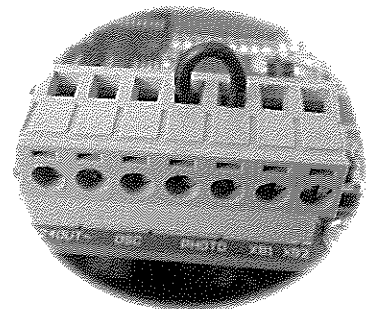
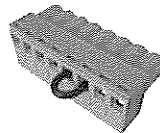

9. Loop Detector

First insert the **LOOP DETECTOR BOARD** into the **CONTROL BOARD**, and then connect the twisted-pair to the "18" and "19" terminals.

10. Solar Panel

Please refer to the manual instruction of solar panel and controller separated.

Setting Of the Control Board

WARNING: Cut off the power before change the settings. Keep away from the gate during you set the gate opener system in case of the unexpected gate moving. Always ask the help of professional technician /electrician if you have any question.

1. DIP Switches

The DIP switches are used to set the running time of the motor in pedestrian mode, fine adjust the soft stop period of the motor, auto close time of the gate opener and fast change the open/close direction which is determined by the position of the gate opener installed.

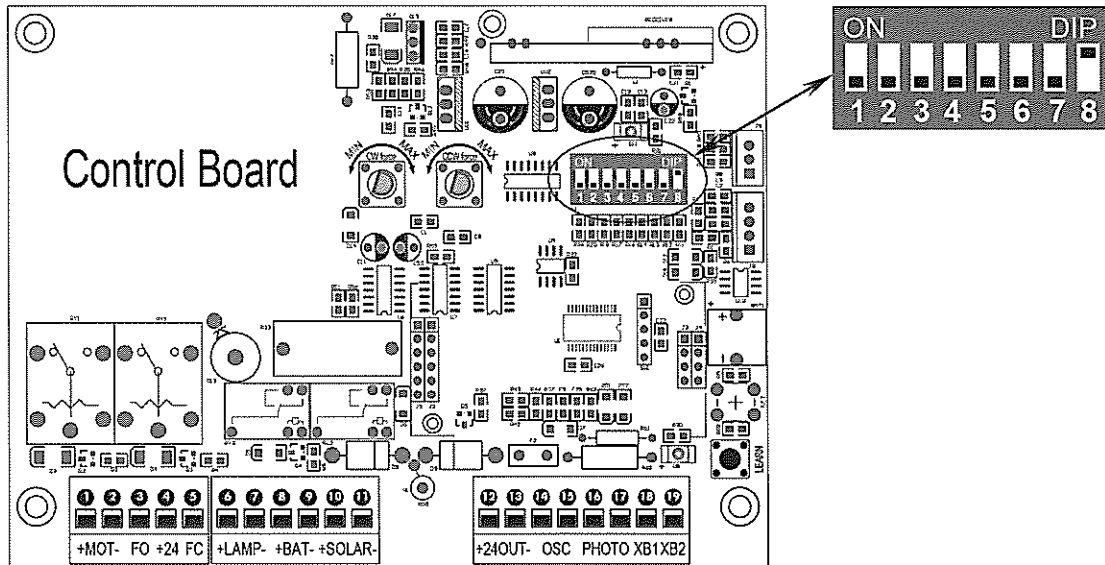

DIP Switch #1–#2: Running time of the motor in Midway Mode

DIP Switch #1: ON – 2 Seconds OFF – 0

DIP Switch #2: ON – 4 Seconds OFF – 0

NOTE: The midway mode function would be disabled if both DIP switches are turned off. Factory default setting is disabled.

E.g.  → Running time of the opener in midway mode is 2+4=6 seconds.

DIP Switch #3–#5: Fine adjust the soft stop period of the motor

DIP Switch #3: ON – 0.5 Second OFF – 0

DIP Switch #4: ON – 1 Seconds OFF – 0

DIP Switch #5: ON – 2 Seconds OFF – 0

NOTE: Every time you restart the gate opener after power off, you should use the access control device (such as remote, push button and etc.) to operate the gate operator to run for a complete opening cycle and a complete closing cycle. You would achieve the soft stop in your next opening/closing cycle. Factory default soft stop time is 1 Seconds. You can turn the DIP switches on/off to fine adjust the soft stop time to meet your actual needs.

E.g.  → The soft stop period of the motor is 0.5+1=1.5 seconds.

DIP Switch #6–#7: Auto close time of the gate operator

DIP Switch #6: ON – 30 Seconds OFF – 0

DIP Switch #7: ON – 60 Seconds OFF – 0

NOTE: The auto close function would be disabled if both DIP switches are turned to off (factory default setting).

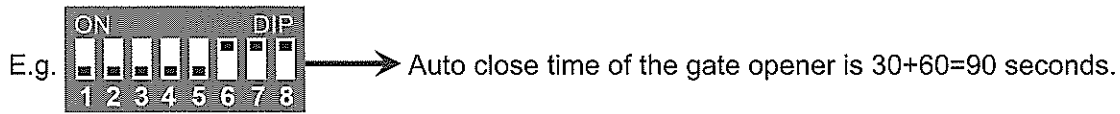

DIP Switch #8: Left/Right open

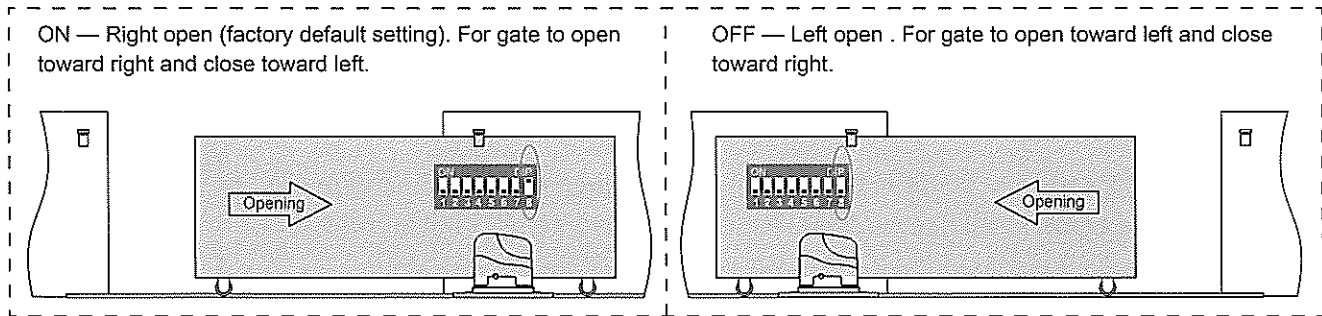

2. Potentiometers

Potentiometer A and B are used to adjust the stall force of the gate operator. One for opening force and another for closing force. Turn the potentiometer clockwise to increase the stall force. Turn the potentiometer counter-clockwise to decrease the stall force.

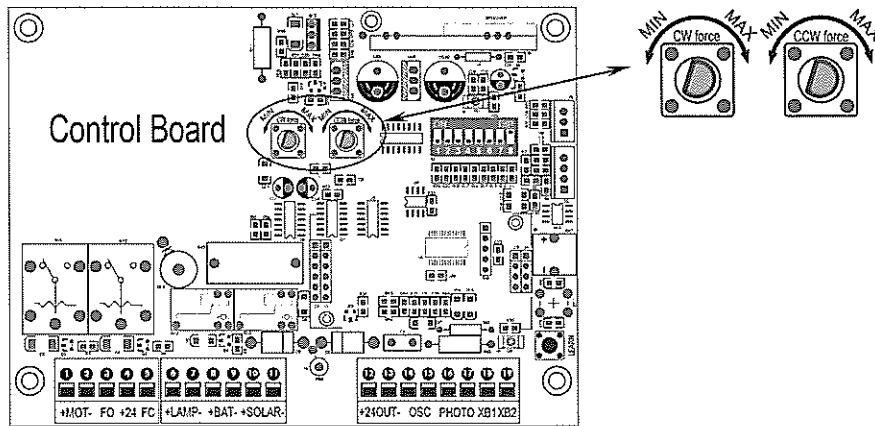

Test the reversing sensitivity

For the sake of safety, it is very important to test the reversing sensitivity as soon as the control board set is finished. The reversing sensitivity adjustment is inverse correlation with stall force adjustment in potentiometer A and B. In other word, the stall force level is higher; the reversing sensitivity level is lower. Put an immobile object along the gate path, and then operate the gate to strike it during the open and close cycles. The gate must reverse as soon as object is struck with it. If the gate doesn't reverse, please increase the reversing sensitivity by turning the potentiometer in counter-clockwise direction. (Turning the stall force potentiometer toward to MIN position to increase the reversing sensitivity)

Note 1: If the sensitivity setting is too higher, the gate will stop or reverses very easy by itself while there is little obstruction or resistance such as strong wind or heavy snow sometimes.

Note 2: Always check the gate reversing function every each time of control board set or restart after power off.

How to learn or erase the remote

Learn the remote

Press and release the learn button, the **REM LED** light will be on, then press the key in the remote twice in 2 seconds, the **REM LED** light will flash for 4 seconds. Now the remote has been learnt successfully.

Erase all the remote codes

Press and hold the learn button until the **REM LED** light is off. Now all remote codes have been erased.

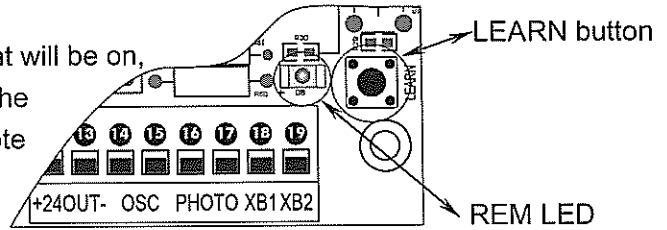

How to use the remote to control the opener

Key A is used to operate the operator to work alternately (open-stop-close-stop-open). When the Midway Mode function is enabled, **Key B** is used to achieve the Midway Mode function (open the gate for the pre-setting time). When the Midway Mode function is disabled, the operator works alternately (open-stop-close-stop-open) by pressing **Key B**.

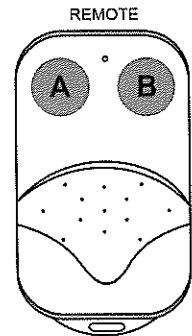

Troubleshooting

Have a multi-meter to check voltage and continuity. Use caution when checking high voltage terminals.

Symptom	Possible Solution(s)
The remote control does not emit any single	Check if the batteries are exhausted, replace them if necessary.
The opener doesn't run. Power LED is OFF	<ol style="list-style-type: none"> 1. Make sure that the power cord is properly plugged into the mains outlet. 2. Check the fuse is blown in the control board; if necessary, identify the reason for the failure and then replace a new one.
The opener doesn't run. Power LED is ON	Make sure the photocell beam is not blocked if the photocell is used. Check the terminal 8 should be shorted with terminal 9 by a jumper wire. Please reset this jumper wire if it is loss.
The gate starts but it is immediately stop or reverse	<ol style="list-style-type: none"> 1. The selected force is too small to move the gate. Turn the Potentiometer clock-wise to increase the force. 2. Disconnect the gate from the gate operator and check that the gate slides freely without any binding.

Maintenance

Every six months check the following items for proper operation of the unit.

- * Lubricate shafts.
- * Keep operator clean at all times.
- * Check for loose or corroded wire
- * Ensure the operator is well earthed, and correctly terminated.
- * Always check the Stop/Reverse in case of obstruction function when performing any maintenance. If this function can't be made operable, remove this operator from service until the cause of the malfunction is identified and corrected.



According to Waste of Electrical and Electronic Equipment (WEEE) directive, WEEE should be separately collected and treated. If at any time in future you need to dispose of this product please do NOT dispose of this product with household waste. Please send this product to WEEE collecting points where available.